

PANZERKAMPFWAGEN PZKPFW II AUSF. -F

Custom Modell



**Bauanleitung
Instruction**

in cooperation with

Blue Brixx

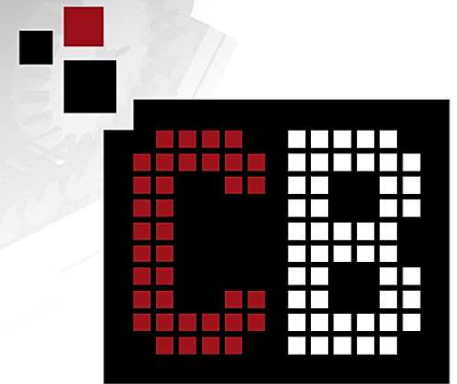

CUSTOM**BRICKS**

1

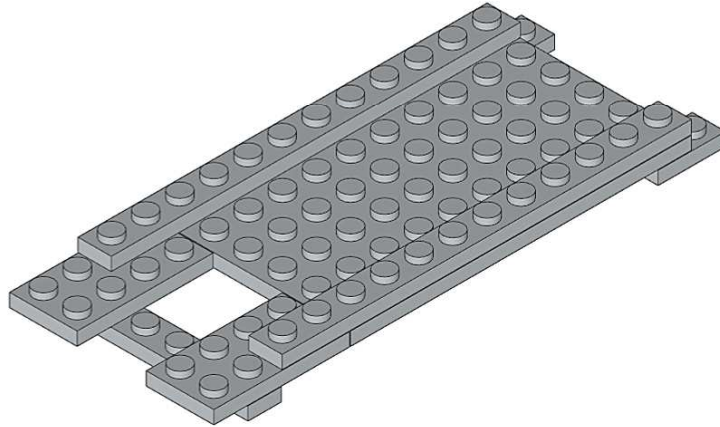
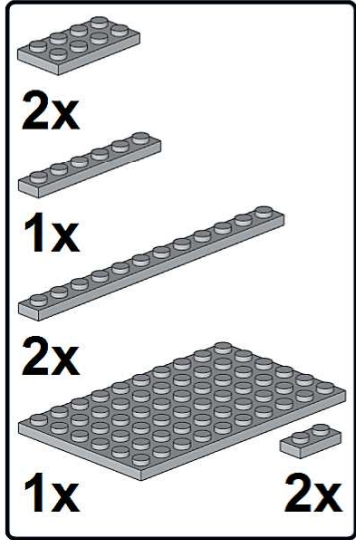

2

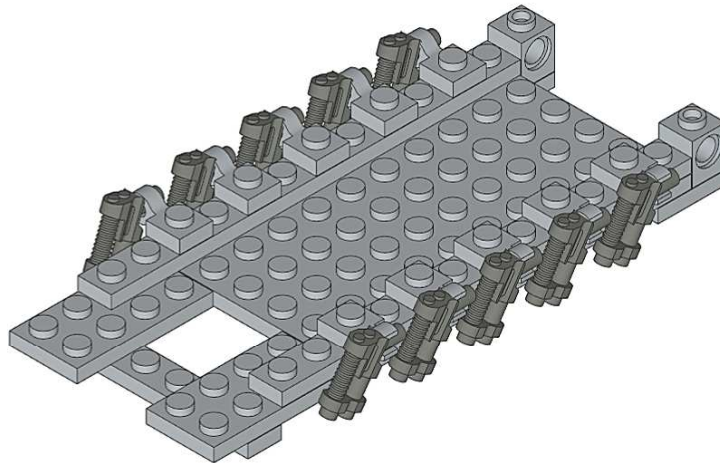
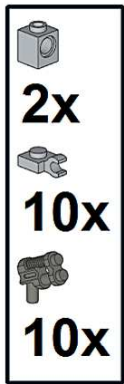

3

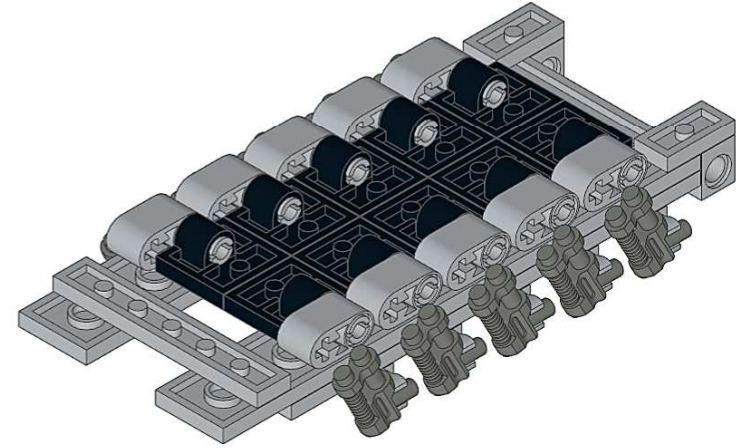
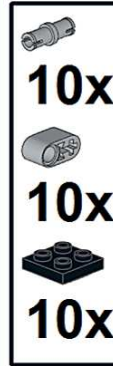

4

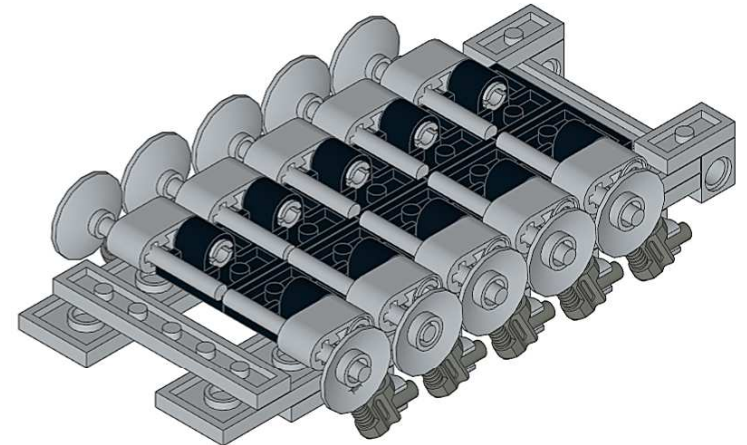





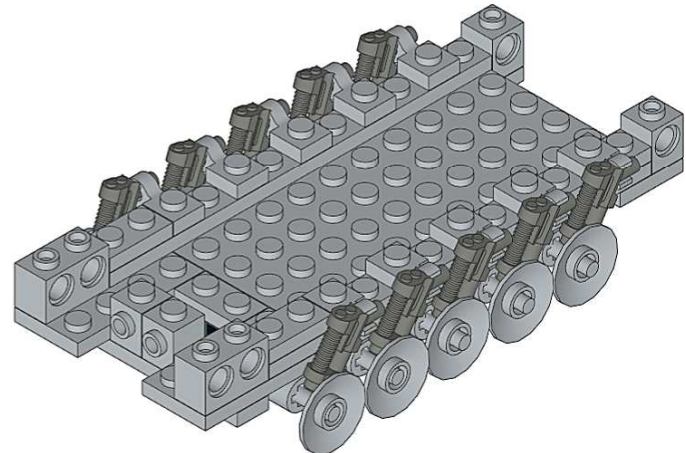



5

-  3x
-  2x
-  2x







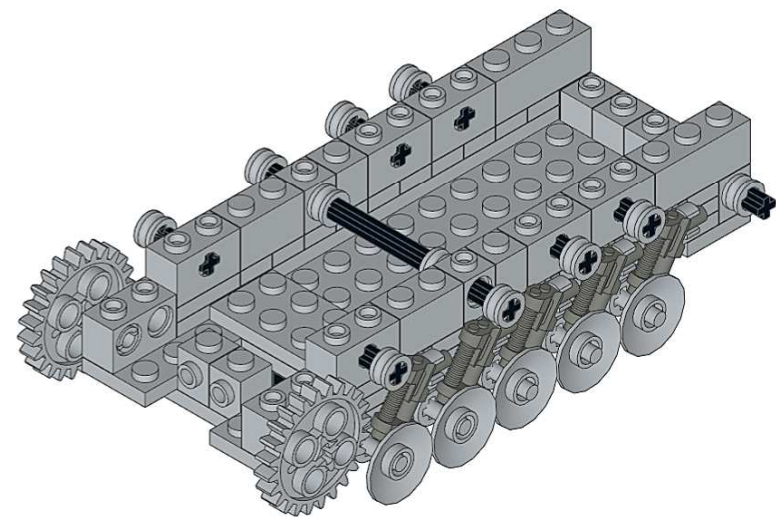

7

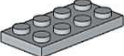
-  2x
-  6x
-  2x
-  10x
-  2x
-  2x
-  1x
-  6x
-  2x



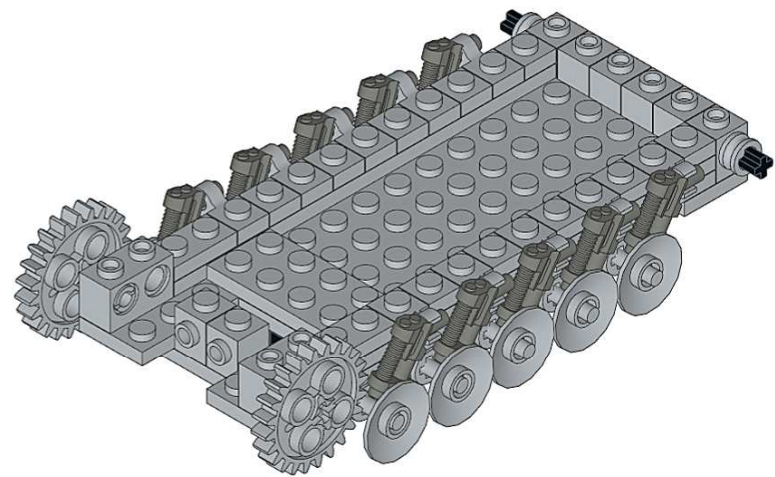

6

-  2x
-  1x
-  1x
-  10x
-  2x
-  2x
-  4x





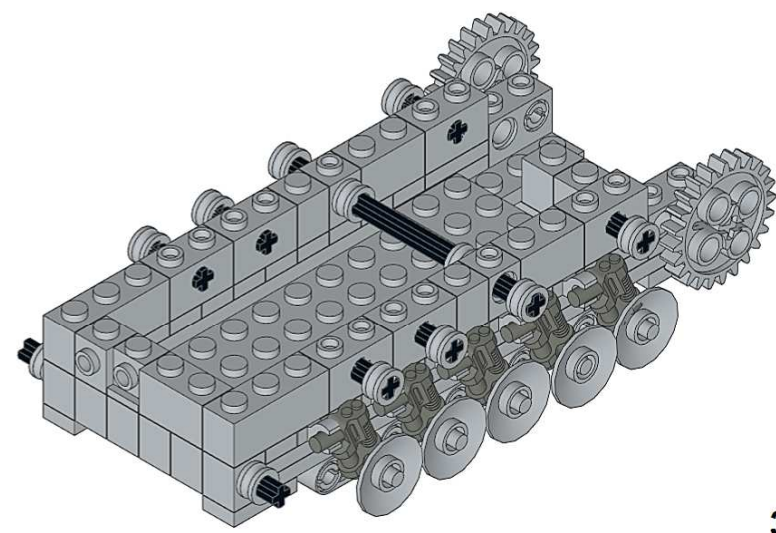

8

-  1x
-  1x
-  1x





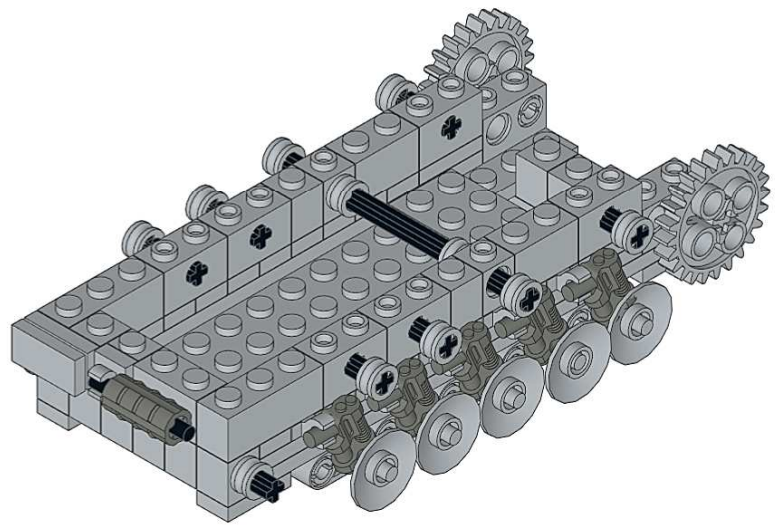

9

-  1x
-  1x
-  1x
-  1x
-  1x

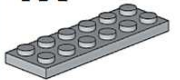
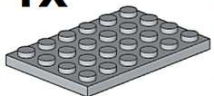





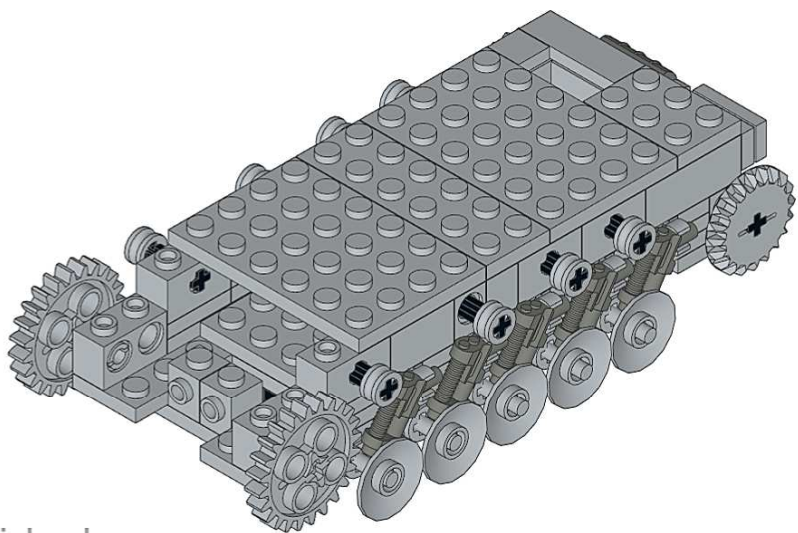

10

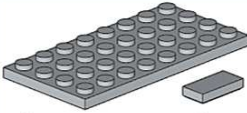
-  1x
-  1x
-  1x
-  2x
-  1x
-  2x
-  1x



11

-  1x
-  1x
-  1x
-  4x
-  1x
-  2x

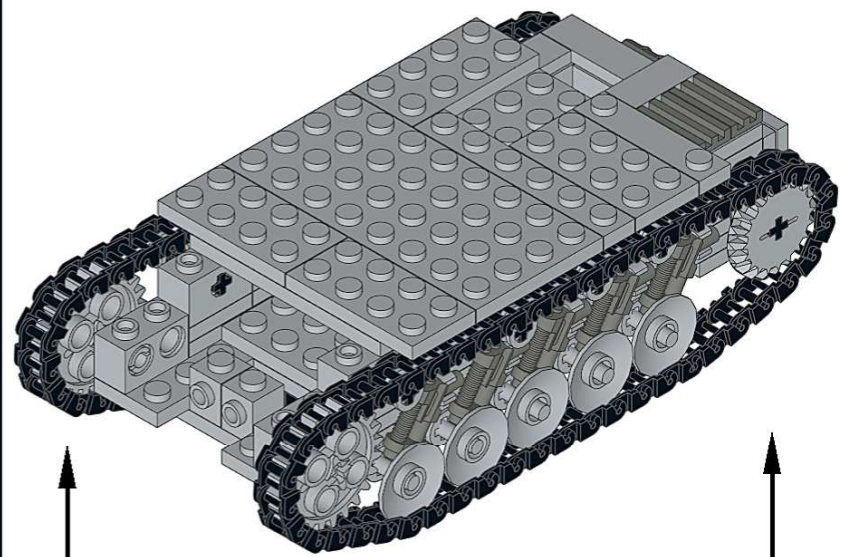

1

2x 1x 2x 1x

2

1x 1x
2x 5x 1x

3

2x 4x
1x 1x

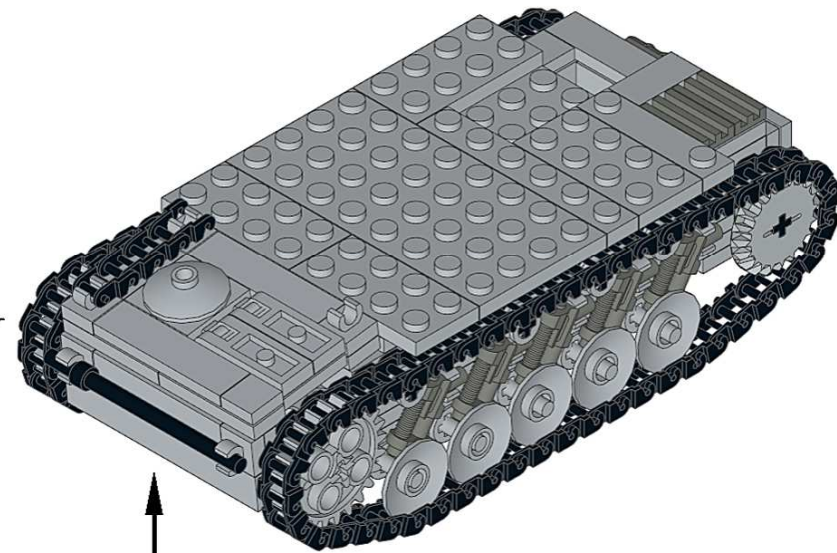
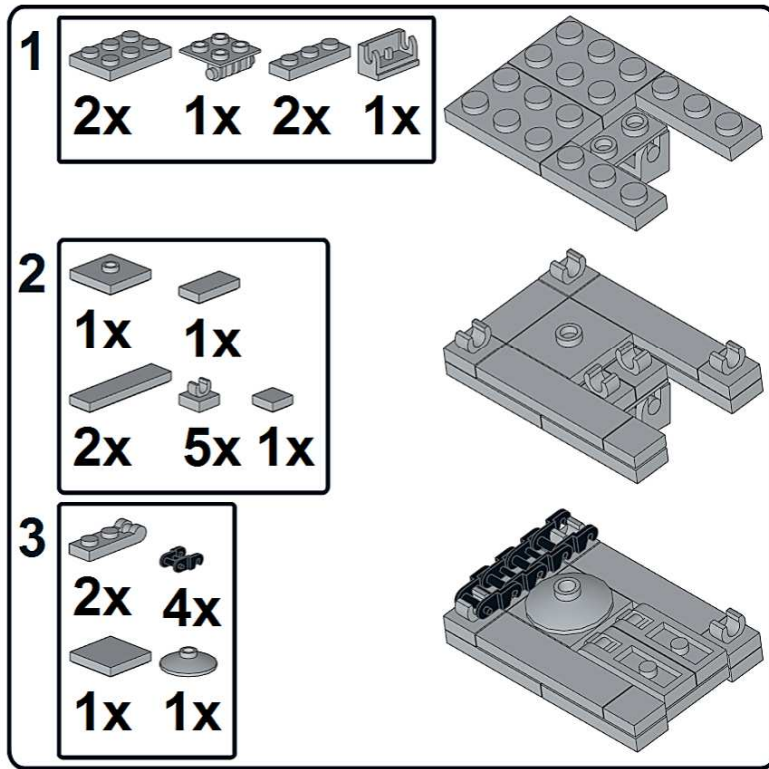

1

1x 1x

2





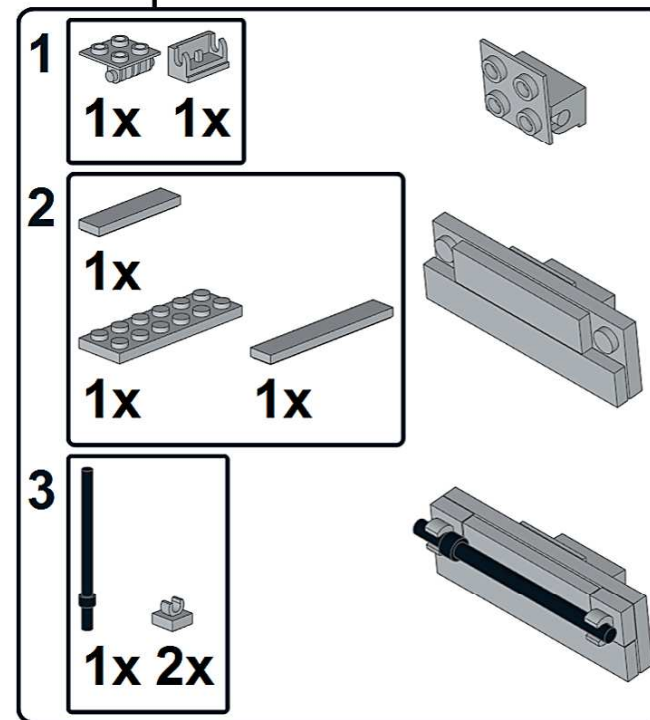

1x
1x 1x

3

1x 2x







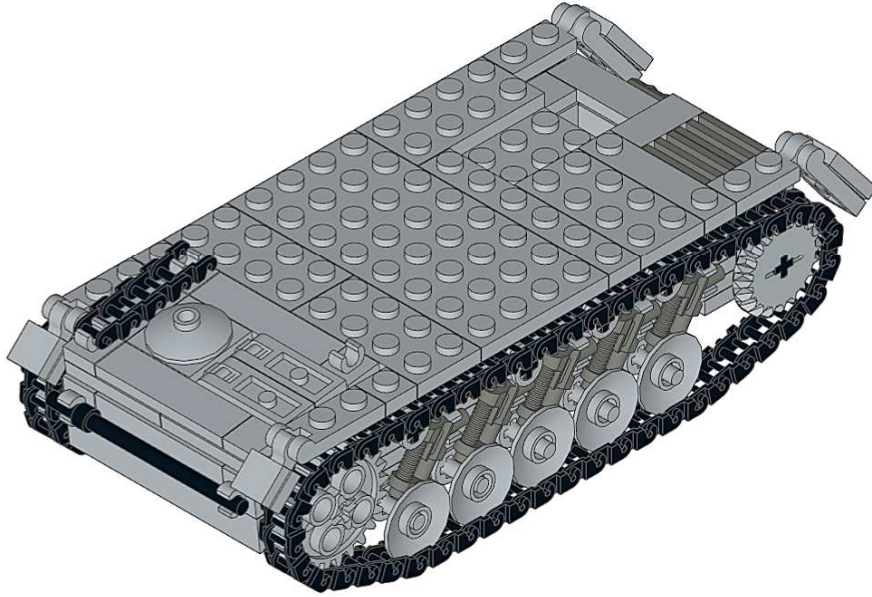



13

- 2x 
- 2x 
- 2x 
- 2x 
- 4x 
- 2x 











14

-  5x
- 1x  3x  1x
-  1x  4x  1x
-  3x  3x  1x









15

-  1x  2x
-  1x  1x
-  1x  4x
-  1x  1x





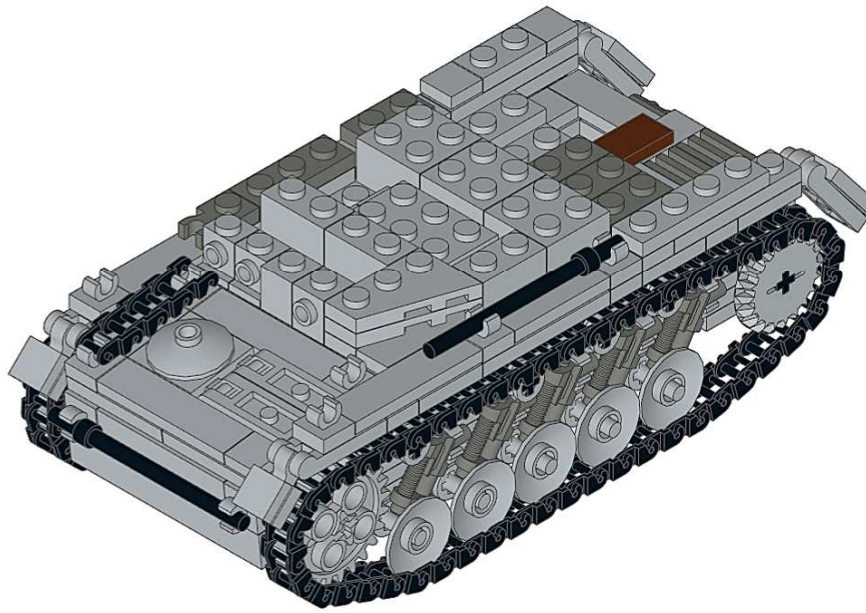

16

-  **3x**
-  **2x**
-  **2x**
-  **1x**
-  **3x**
-  **1x**







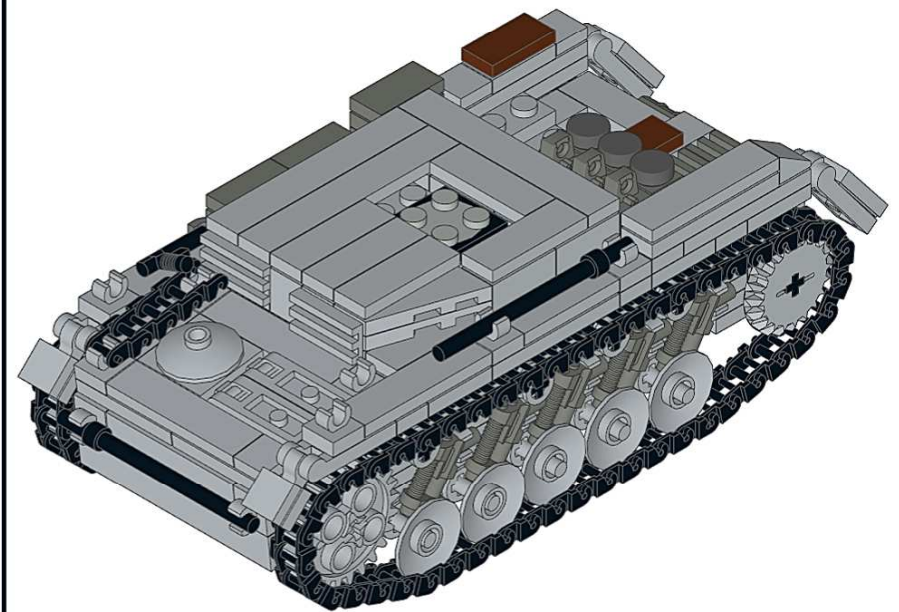



18

-  **2x**
-  **1x**
-  **1x**
-  **5x**
-  **3x**



17

-  **1x**
-  **3x**
-  **3x**
-  **2x**
-  **1x**
-  **1x**
-  **1x**
-  **1x**

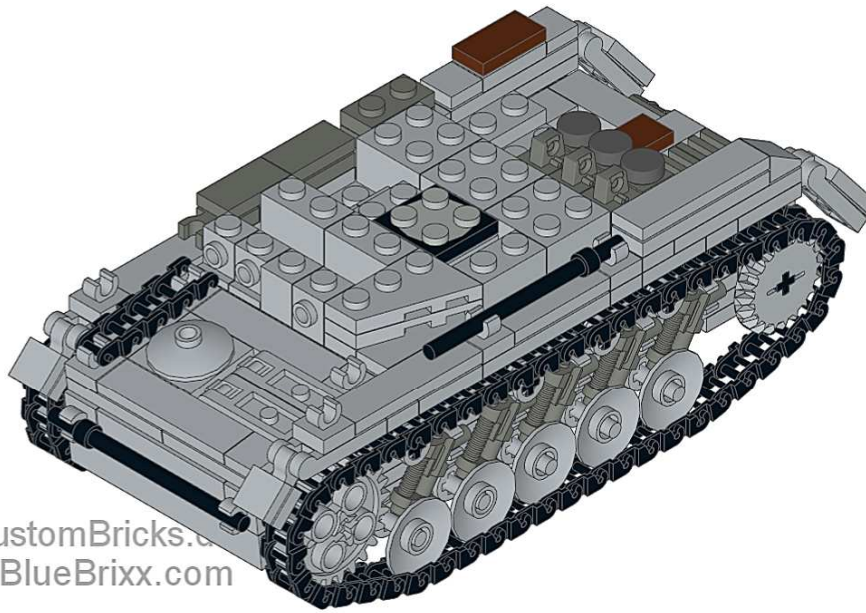

1

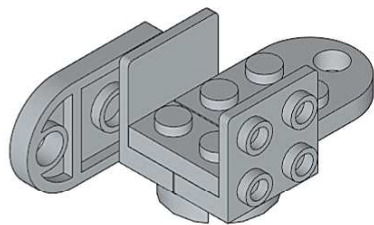
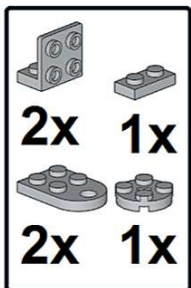

4

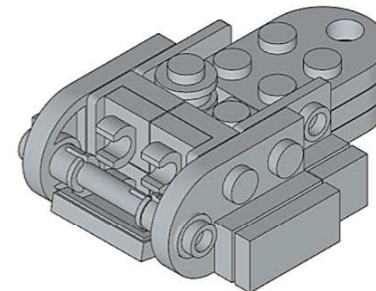
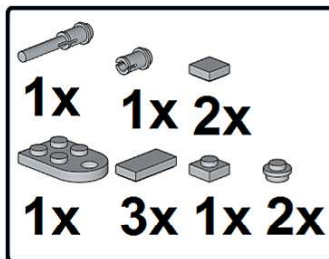

2

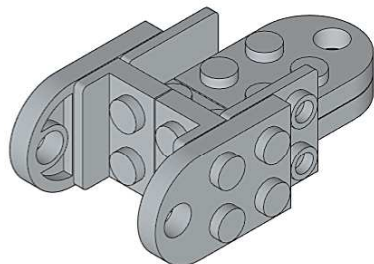
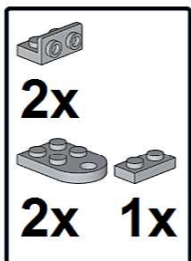

5

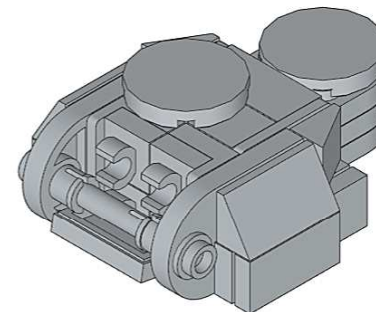
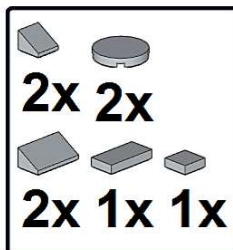

3

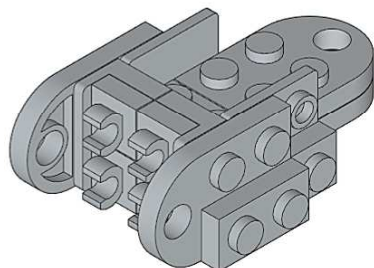
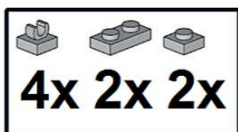

6

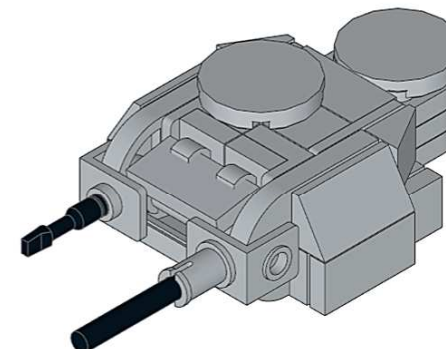
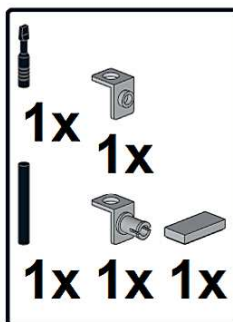

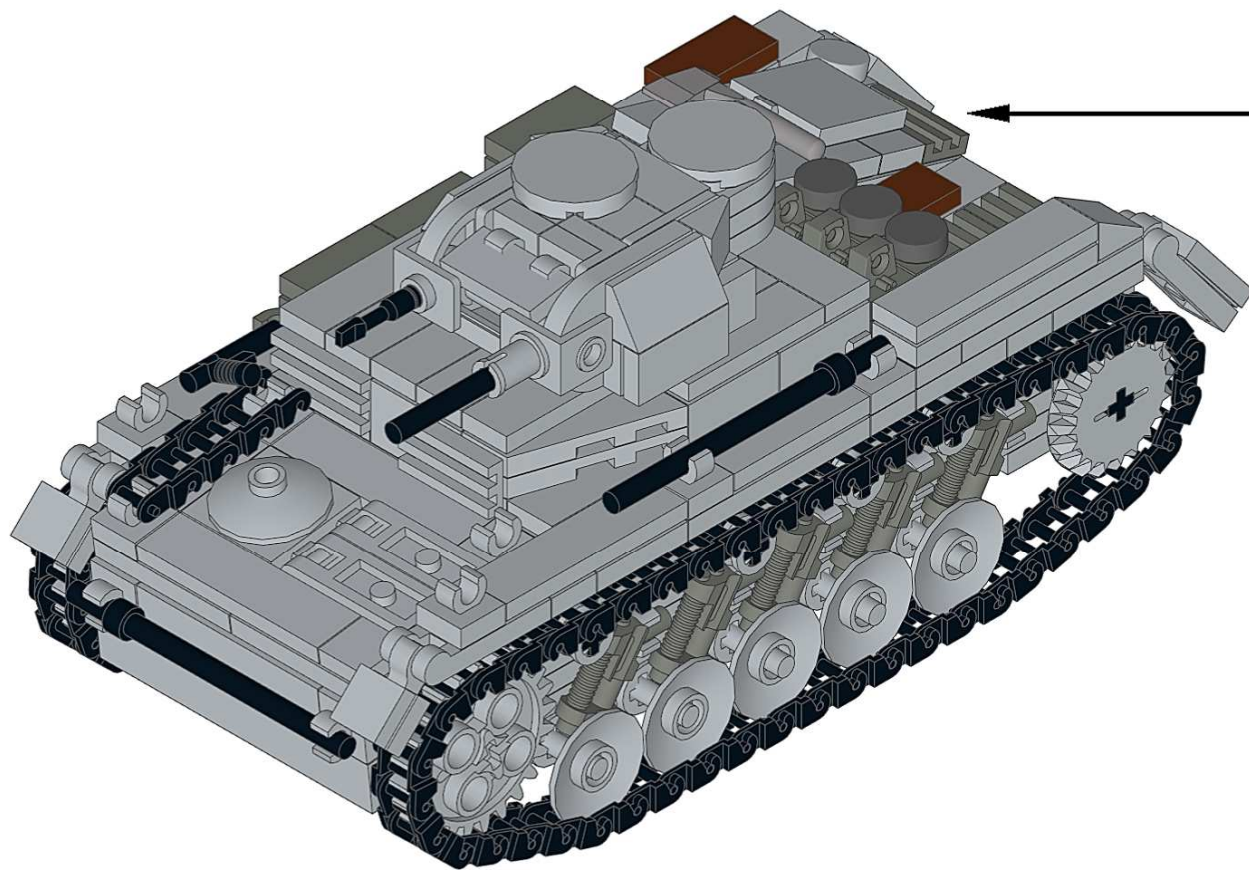

1

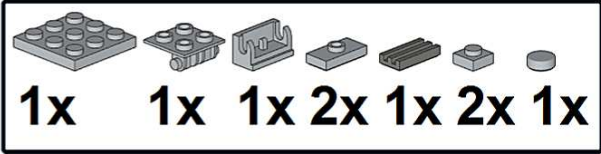

1x 1x 1x 2x 1x 2x 1x

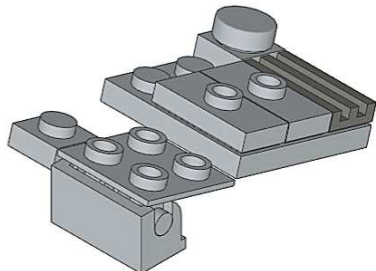

2

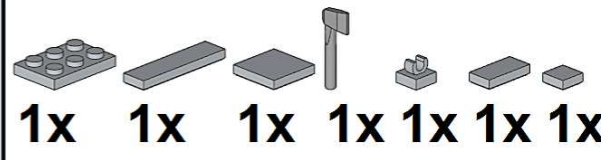

1x 1x 1x 1x 1x 1x 1x

